



# Release list for operating materials

## Lubrication technology

for component manufacturing  
of the Volkswagen Group  
„Trade-specific part“

Date of issue: 01 January 2024  
Version: 2.6

## Change history

Issue	Date:	Description
1.9	01.01.2017	Editorial updates (Version 1.9)
2.0	01.01.2018	Editorial updates (Version 2.0)
2.1	01.01.2019	Editorial updates (Version 2.1) Adaptation of template to cover sheet and structure of group template Component.
2.2	01.01.2020	Editorial updates (Version 2.2) Note supplemented by change identification.
2.3	01.01.2021	Editorial updates (Version 2.3)
2.4	01.01.2022	Editorial updates (Version 2.4) File size and nomenclature for the file name adjusted under Notes on this document template.
2.5	01.01.2023	Editorial updates (Version 2.5)
2.6	01.01.2024	Editorial updates (Version 2.6)

### Notes:

This document supplements the mechanical equipment release list for component production of the Volkswagen Group "Technology-specific part".

In particular, VOLKSWAGEN AG reserves all rights to the technical utilization of the information provided in these specifications, including the registration and granting of industrial property rights.

Changes to content are highlighted in grey.

## Table of contents

<b>Change history</b> .....	2
1. Contact persons:.....	5
2. Notes: .....	6
2.1 Purpose of use .....	6
2.2 General information.....	6
3. Overview.....	7
3.1 Single-line system .....	7
3.1.1 Oil lubrication unit GE21 .....	7
3.1.2 Fluid Grease lubrication unit GE51.....	7
3.2 Single-line distributor.....	8
3.2.1 Single-line distributor for oil VEI-A.....	8
3.2.2 Single-line distributor for fluid grease VEI-F .....	8
3.3 Two-line distributors.....	9
3.3.1 VZE and VZF in block design* .....	9
3.3.2 VZB in element design* .....	9
3.4 Level switch KFA-A .....	9
3.5 Grease lubrication pumps.....	10
3.5.1 Multi-line pump unit GMO-A01 .....	10
3.5.2 Multi-line pump unit GMO-A01 with stainless steel reservoir* .....	10
3.5.3 Multi-line pump unit GMA-B02/C02 .....	11
3.5.4 Multi-line pump unit GMA-B02/C02 with stainless steel reservoir * .....	11
3.6 Progressive distributors .....	12
3.6.1 Progressive distributor in block design VPB.....	12
3.6.2 Progressive distributor in plate design VPA.....	12
3.6.3 Progressive distributor in element design VPI* .....	12
3.7 Gear-type pump units .....	13
3.7.1 Gear-type pump unit vertical GFZ.....	13
3.7.2 Gear-type pump unit vertical horizontal GFM .....	13
3.8 Compact pumps .....	14
3.8.1 Piston pump GMV-B.....	14
3.8.2 Piston pump GMK-B .....	14
3.8.3 Containers for GMK-B .....	15
3.9 Volume flow regulator and limiter * .....	15
3.10 Volume flow monitoring devices.....	15
3.10.1 Flow checking device KPD* .....	15
3.10.2 Oval gear flowmeter KUO-A* .....	16
4. Accessories .....	16
4.1 Hoses .....	16
4.2 Pipelines.....	16
4.3 Pressure relief valves.....	17
4.3.1 Pressure relief valve for line installations .....	17
4.3.2 Pressure relief valve for gear pumps.....	17

---

4.3.3 Pressure relief valves for pump elements.....	17
4.4 Check valves .....	18
4.4.1 Check valve for VPA-B .....	18
4.4.2 Check valve for VPB-B .....	18
4.4.3 Check valves in general .....	18
4.4.4 Check valve for line installation .....	19
4.5 Push-in fittings.....	19
4.6 Pressure gauge .....	19
4.7 Filters .....	19
4.7.1 Oil filter.....	19
4.7.2 Lubricant filter .....	20
4.8 Directional valves .....	20
4.9 Pressure switch.....	20
4.10 Mounting plates / oil pans.....	21
4.11 Check valve cartridges for GMK-B .....	21
4.12 Chain lubrication pinion .....	22
4.13 Lubrication roll.....	22
4.14 Lubrication gear .....	22

## 1. Contact persons:

Eugen WOERNER GmbH & Co. KG  
Hafenstraße 2  
D - 97877 Wertheim  
Tel.: +49 (0) 9342 803-0  
E-Mail: [info@woerner.de](mailto:info@woerner.de)

	Responsible	Contact details
Andreas Frank Key Account Manager Volkswagen	Support for locations worldwide	Tel.: +49 (0) 9342 803-330 Mobile: +49 (0) 176 22 87 69 53 E-Mail: <a href="mailto:andreas.frank@woerner.de">andreas.frank@woerner.de</a>
Field service Germany	Responsible	Contact details
Georg Remm Sales Engineer North Region	Support for the locations: Braunschweig, Chemnitz, Dresden, Emden, Hannover, Kassel, Osnabrück, Salzgitter, Wolfsburg, Zwickau	30982 Pattensen Tel.: +49 (0) 176 22 87 69 54 E-Mail: <a href="mailto:georg.remm@woerner.de">georg.remm@woerner.de</a>
Marc Liebhäuser Sales Engineer southeast region	Ingolstadt	86720 Nördlingen Tel.: +49 (0) 176 22 17 57 71 E-Mail: <a href="mailto:marc.liebhaeuser@woerner.de">marc.liebhaeuser@woerner.de</a>
Representation Poland	Responsible	Contact details
Karolina Miller Representation Poland Advanced Automatic Lubrication Systems S.A.	Poland	ul. Emilii Plater 25-27 59-220 Legnica Poland Tel.: +48 720 704 562 E-Mail: <a href="mailto:k.miller@aals.pl">k.miller@aals.pl</a>
Katarzyna Szczepanik Representation Poland Advanced Automatic Lubrication Systems S.A.	Poland	ul. Emilii Plater 25-27 59-220 Legnica Poland Tel.: +48 601 782 870 E-Mail: <a href="mailto:k.Szczepanik@aals.pl">k.Szczepanik@aals.pl</a>
Representation Czech Republic	Responsible	Contact details
Jana Sipkova Representation Czech Republic TROMA-MACH s.r.o.	Czech Republic	Jihlavská 26 59101 Zdár nad Sázavou / Czech Republic Tel.: +420 566 62 07 21 E-Mail: <a href="mailto:jana.sipkova@troma.cz">jana.sipkova@troma.cz</a>

---

Office sales Germany	Responsible	Contact details
Cornelia Nenner Office sales		Tel.: +49 (0) 9342 803-312 E-Mail: <a href="mailto:cornelia.nenner@woerner.de">cornelia.nenner@woerner.de</a>
Sandra Beck Office sales		Tel.: +49 (0) 9342 803-310 E-Mail: <a href="mailto:sandra.beck@woerner.de">sandra.beck@woerner.de</a>

## 2. Notes:

### 2.1 Purpose of use

The basis for the following release list is the current edition of the **mechanical specifications for component manufacturing of the Volkswagen Group**. The respective requirements and restrictions must be complied with.



### 2.2 General information

Components marked with "\*" are to be used exclusively in the "Foundry" area.

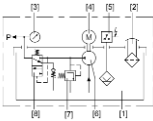

### 3. Overview

#### 3.1 Single-line system

##### 3.1.1 Oil lubrication unit GE21

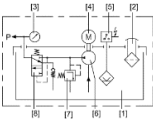

Article description	Version	Symbol	Picture	Documentation
Medium: Oil from 30 to 1500mm <sup>2</sup> /s; Max. 30bar; Reservoir: 3l plastic (GE21/B), 6l plastic (GE21/C) Flow volume: 0.5l/min; Level control: Min./adv; Pressure gauge; Filling connection: Walther coupling MD-006-2-WR013; Motor: 230/400V AC 50Hz, 440V AC 60Hz; Connection via Harting plug HAN6E	GE21/B – 2 – 5 7 4  GE21/C – 2 – 5 7 4			<a href="#">Data sheet</a>

##### 3.1.2 Fluid Grease lubrication unit GE51



Article description	Version	Symbol	Picture	Documentation
Medium: Fluid greases of NLGI classes 00-000; Max. 40bar; Reservoir: 3l plastic (GE51/B), 6l plastic (GE51/C), Flow volume: 0.2 l/min; Level control: Min./adv. via ultrasonic sensor; Pressure gauge; Filling connection: Walther coupling MD-006-2-WR013; Motor: 230/400V AC 50Hz, 440V AC 60Hz; Connection via Harting plug HAN6E	GE51/B – 2 – 2 7 4  GE51/C – 2 – 2 7 4			<a href="#">Data sheet</a>

### 3.2 Single-line distributors

#### 3.2.1 Single-line distributor for oil VEI-A

Article description	Version	Symbol	Picture	Documentation
<p>Medium: Oil up to 2000mm<sup>2</sup>/s; Max. 45bar Material: Housing - aluminium, dosing nipple - brass; Size 1: 2-5 outlets, 0.01 - 0.16 cm<sup>3</sup>/outlet, pressure connections M10x1; Size 2: 2-5 outlets, 0.1 - 0.6 cm<sup>3</sup>/discharge, pressure connections M12x1; Size 3: 2-3 outlets, 0.2 - 1.5 cm<sup>3</sup>/outlet Pressure connections M12x1; Outlet screw connections: M8x1</p>	<p>VEI-A/X/X/.../X</p> <p>X ≙ (Freely selectable according to data sheet)</p>			<p> <a href="#">Data sheet</a></p>

#### 3.2.2 Single-line distributor for fluid grease VEI-F

Article description	Version	Symbol	Picture	Documentation
<p>Medium: Size B and C - fluid greases of NLGI classes 000-00, size D - fluid greases of NLGI class 000-0; Max. 45bar; Material: Housing - aluminium, dosing nipple - brass; Size B: 2-5 outlets, 0.01 - 0.1 cm<sup>3</sup>/outlet, Pressure connections M10x1 Size C: 2-5 outlets, 0.1 - 0.3 cm<sup>3</sup>/discharge, pressure connections M12x1 Size D: 2-3 outlets, 0.1 - 0.3 cm<sup>3</sup>/outlet, Pressure connections: M12x1; Outlet screw connections: M8x1</p>	<p>VEI-F/X/X/.../X</p> <p>X ≙ (Freely selectable according to data sheet)</p>			<p> <a href="#">Data sheet</a></p>



### 3.3 Two-line distributors

#### 3.3.1 VZE and VZF in block design\*

*\*to be used exclusively in the "Foundry" area*

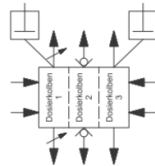
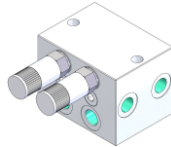

Article description	Version	Symbol	Picture	Documentation
Two-line manifold in block design; Material: steel or stainless steel; 2 - 8 outlets, 0,2 – 3,0 cm <sup>3</sup> /outlet; optical or electrical monitoring;	VZE-I/00/X/X/0  VZF-B/00/W/X-E 0 0 X -...  X ≙ (Freely selectable according to data sheet)			VZE-I <a href="#">Data sheet</a>  VZF-B: <a href="#">Data sheet</a>

#### 3.3.2 VZB in element design\*

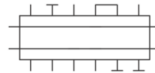
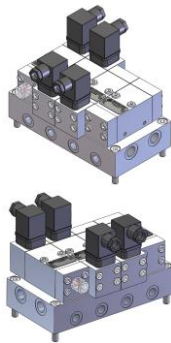
*\*to be used exclusively in the "Foundry" area*

Article description	Version	Symbol	Picture	Documentation
Two-line distributor in element design; Material: aluminium; 2 - 12 outlets, 0,5 – 7,0 cm <sup>3</sup> /outlet; optical or electrical monitoring	VZB-A/00/X/X/X/.../X  X ≙ (Freely selectable according to data sheet)			<a href="#">Data sheet</a>

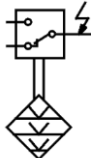
### 3.4 Level switch KFA-A

Article description	Version	Symbol	Picture	Documentation
Medium: Density>0.7 g/cm <sup>3</sup> , medium temperature: 0...90°C; Max. 1 bar; Material: Tube and thermostat brass, float PUR hard foam; IP65; Switching voltage: 30VDC	KFA-A-01/F/0/0/N/N/Z5N/X  X ≙ (Freely selectable according to data sheet)			<a href="#">Data sheet</a>

### 3.5 Grease lubrication pumps

#### 3.5.1 Multi-line pump unit GMO-A01

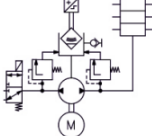
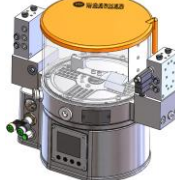

Article description	Version	Symbol	Picture	Documentation
<p><b>Medium: Grease up to NLGI class 2;</b>            Max. 300 bar;            Speed: 30 rpm;            Reservoir: 2 / 4l polyamide, 5l polyester;            Level control:            Min / advance / max;            Filling connection: Walther coupling MD-006-2-WR 013;            Pump elements: 1 ... 3;            Delivery volume: 0.11 cm<sup>3</sup>/stroke;            Voltage: 24V DC;            Electrical connection: M12x1 plug;            Special features:            Lube Care, directly attachable distributors and directional valves</p>	<p>GMO-A01/00/2/C/D/X/X/X/X/X/0/X/0            GMO-A01/00/4P/C/D/X/X/X/X/X/0/X/0            GMO-A01/00/5/KK/D/X/X/X/X/X/0/X/0</p> <p>X ≙ (Freely selectable according to data sheet)</p>			<p><a href="#">Data sheet</a>  <a href="#">3D-model</a></p>

#### 3.5.2 Multi-line pump unit GMO-A01 with stainless steel reservoir\*

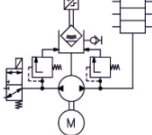
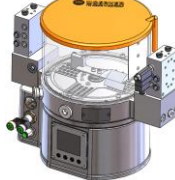
*\*to be used exclusively in the "Foundry" area*

Article description	Version	Symbol	Picture	Documentation
<p><b>Medium: Grease up to NLGI class 2;</b>            Max. 300 bar;            Speed: 30 rpm;            Reservoir: <b>7l stainless steel;</b>            Level control:            Min / advance / max;            Filling connection: Walther coupling MD-006-2-WR 013;            Pump elements: 1 ... 3;            Delivery volume: 0.11 cm<sup>3</sup>/stroke;            Voltage: 24V DC;            Electrical connection: M12x1 plug;            Special features:            Lube Care, directly attachable distributors and directional valves</p>	<p>GMO-A01/00/7V/C/D/X/X/X/X/X/0/X/0</p> <p>X ≙ (Freely selectable according to data sheet)</p>			<p><a href="#">Data sheet</a>  <a href="#">3D-model</a></p>

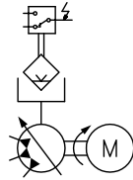

### 3.5.3 Multi-line pump unit GMA-B02/C02

Article description	Version	Symbol	Picture	Documentation
<p>Medium: <b>Grease up to NLGI class 2;</b>            Max. 250 bar;            Speed: 27 rpm;            Reservoir: 2 / 4l polyamide, 5l polyester;            Level control:            Min / advance / max;            Pump elements: 1 ... 4;            Delivery volume:            0.08 ... 0.22 cm<sup>3</sup>/stroke, adjustable;            Filling connection: Walther coupling MD-006-2-WR013;            Voltage: GMA-B02 - 24V DC, GMA-C02 - 230/400 V 50 Hz and 440V 60Hz;            Motor connection:            GMA-B via M12x1 plug connection,            GMA-C via Harting connector HAN6E</p>	<p>DC motor:            GMA-B02/00/2/C2/0/D/X/X/X/X/X            GMA-B02/00/4P/C2/0/D/X/X/X/X/X            GMA-B02/00/5/K/K/D/X/X/X/X/X</p> <p>three-phase motor:            GMA-C02/00/2/C2/0/D/X/X/X/X/X/25E            GMA-C02/00/4P/C2/0/D/X/X/X/X/X/25E            GMA-C02/00/5/K/K/D/X/X/X/X/X/25E</p> <p>X ≙ (Freely selectable according to data sheet)</p>			<p>GMA-B02:            Special version S0301  <a href="#">Data sheet</a>  <a href="#">3D-model</a></p> <p>GMA-C02:  <a href="#">Data sheet</a>  <a href="#">3D-model</a></p>

Note: All pumps are also available filled with lubricant on request

### 3.5.4 Multi-line pump unit GMA-B02/C02 with stainless steel reservoir \*

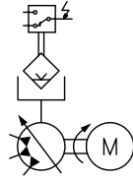
*\*to be used exclusively in the "Foundry" area*

Article description	Version	Symbol	Picture	Documentation
<p>Medium: <b>Grease up to NLGI class 2;</b>            Max. 250 bar;            Speed: 27 rpm;            Reservoir: <b>7l stainless steel;</b>            Level control:            Min / advance / max;            Pump elements: 1 ... 4;            Delivery volume:            0.08 ... 0.22 cm<sup>3</sup>/stroke, adjustable;            Filling connection: Walther coupling MD-006-2-WR013;            Voltage: GMA-B02 - 24V DC, GMA-C02 - 230/400 V 50 Hz and 440V 60Hz;            Motor connection:            GMA-B via M12x1 plug connection,            GMA-C via Harting connector HAN6E</p>	<p>Gleichstrommotor            GMA-B02/00/7V/C/0/D/X/X/X/X/X</p> <p>Drehstrommotor:            GMA-C02/00/7V/C/0/D/X/X/X/X/X/25E</p> <p>X ≙ (Freely selectable according to data sheet)</p>			<p>GMA-B02:            Special version S0301  <a href="#">Data sheet</a>  <a href="#">3D-model</a></p> <p>GMA-C02:  <a href="#">Data sheet</a>  <a href="#">3D-model</a></p>

### 3.6 Progressive distributors

#### 3.6.1 Progressive distributor in block design VPB

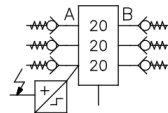
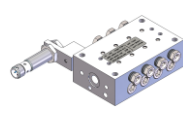
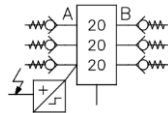
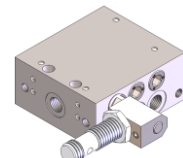
Article description	Version	Symbol	Picture	Documentation
<p>Medium: Oil from min. 7mm<sup>2</sup>/s, greases up to NLGI class 2; Max. 150bar; Material: Aluminium (B) or bronze (H); Number of outlets: 6 ... 20; Electrical function control; Dosing volume: 0.05 ... 0.20 cm<sup>3</sup></p>	<p>VPB-B/00/X/X/X/0/X/.../X VPB-B/00/X/X/X/M3/X/.../X</p> <p>VPB-H/00/X/X/X/0/X/.../X VPB-H/00/X/X/X/M3/X/.../X</p> <p>X ≙ (Freely selectable according to data sheet)</p>			<p><a href="#">Data sheet</a></p> <p><a href="#">3D-model</a></p>
<p>Medium: Greases of NLGI classes 0...2; Max. 350bar; Material: Steel or stainless steel; Number of outlets: 6 ... 22; Electrical function control; Dosing volume: 0.05cm<sup>3</sup>/0.09 ... 0.20 cm<sup>3</sup></p>	<p>VPB-SSV/00/X/X/X/.../X VPB-SSV/00/X/X/X/.../XW<sup>1</sup>X<sup>1</sup></p> <p>X ≙ (Freely selectable according to data sheet) 1Installation of the function check according to data sheet</p>			<p><a href="#">Data sheet</a></p> <p><a href="#">3D-model</a></p>

#### 3.6.2 Progressive distributor in plate design VPA

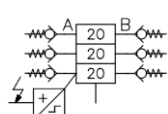
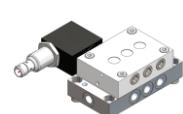
Article description	Version	Symbol	Picture	Documentation
<p>Medium: Oil from min. 7mm<sup>2</sup>/s, greases up to NLGI class 2; Max. 150bar; Material: Aluminium (B) or bronze (H); Number of outlets: 6 ... 20; Electrical function control; Dosing volume: 0.09 ... 0.2 cm<sup>3</sup></p>	<p>VPA-B/00/X/X/X/0/0/X/.../X VPA-B/00/X/X/W/N/X/.../X</p> <p>VPA-H/00/X/X/X/0/0/X/.../X VPA-H/00/X/X/W/N/X/.../X</p> <p>X ≙ (Freely selectable according to data sheet)</p>			<p>VPA-B: <a href="#">Data sheet</a> <a href="#">3D-model</a></p> <p>VPA-H: <a href="#">Data sheet</a> <a href="#">3D-model</a></p>



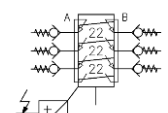
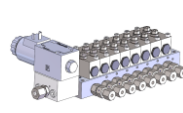

#### 3.6.3 Progressive distributor in element design VPI\*

\*to be used exclusively in the "Foundry" area

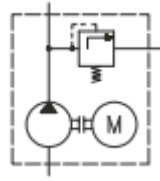

Article description	Version	Symbol	Picture	Documentation
<p>Attachment option for directional control and flow valves 6 to 20 outlets Various function controls Dosing volume 0.10 to 3.70 cm<sup>3</sup></p>	<p>VPI-C/00/X/.../X VPI-D/00/X/.../X</p> <p>X ≙ (Freely selectable according to data sheet)</p>			<p>VPI-C: <a href="#">Data sheet</a> <a href="#">3D-model</a></p> <p>VPI-D: <a href="#">Data sheet</a> <a href="#">3D-model</a></p>

### 3.7 Gear-type pump units

#### 3.7.1 Gear-type pump unit vertical GFZ

Article description	Version	Symbol	Picture	Documentation
<p>Medium: Oil up to 1500mm<sup>2</sup>/s, delivery volume: GFZ-B: 0.06...1 l/min, 35...60bar GFZ-N: 0.8...13.1 l/min, 9...240bar GFZ-L: 2.8...38.3 l/min, 25...185bar</p> <p>Motor: at 50 Hz: 220 - 240/ 380 - 420 V at 60 Hz: 440 - 480 V (special voltages possible); Motor connection: Harting plug HAN10E</p>	<p>GFZ-B/00/X/X/V/2</p> <p>GFZ-N/00/X/X/X/V/2</p> <p>GFZ-L/00/X/X/X/V/2</p> <p>X ≙ (Freely selectable according to data sheet)</p>			<p>GFZ-B:  <a href="#">Data sheet</a></p> <p>GFZ-N:  <a href="#">Data sheet</a></p> <p>GFZ-L:  <a href="#">Data sheet</a></p>

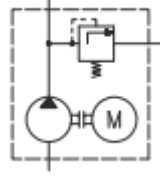
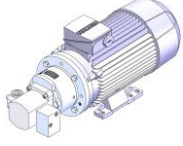
#### 3.7.2 Gear-type pump unit vertical horizontal GFM

Article description	Version	Symbol	Picture	Documentation
<p>Medium: Oil up to 1500mm<sup>2</sup>/s, delivery volume: GFM-N: 0.8...13.1 l/min, 17...240bar GFM-L: 2.8...38.3 l/min, 25...185bar</p> <p>Motor: at 50 Hz: 220 - 240/ 380 - 420 V at 60 Hz: 440 - 480 V (special voltages possible); Motor connection: Harting plug HAN10E</p>	<p>GFM-N/00/X/X/X/2</p> <p>GFM-L/01/00/X/X/V/2</p> <p>X ≙ (Freely selectable according to data sheet)</p>			<p>GFM-N:  <a href="#">Data sheet</a></p> <p>GFM-L:  <a href="#">Data sheet</a></p>

### 3.8 Compact pumps

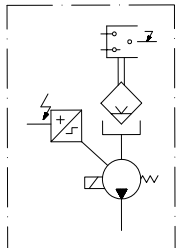
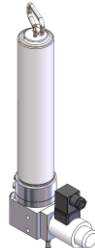

#### 3.8.1 Piston pump GMV-B

Article description	Version	Symbol	Picture	Documentation
<p>Driven by 24 VDC electromagnet; 100% duty cycle; Container for grease cartridges according to DIN 1284 (400 g) Level control; Function check; Outlet <math>\varnothing 4/\varnothing 6</math>; Delivery volume: 25 mm<sup>3</sup>; Plug M12x1</p>	<p>GMV-B/00/M/A/B/F/1/X + 913.405-47 (Adapter M12x1)</p> <p>X <math>\triangleq</math> (Freely selectable according to data sheet)</p>			<p><a href="#">Data sheet</a> <a href="#">3D-model</a></p>

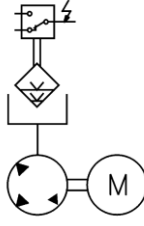
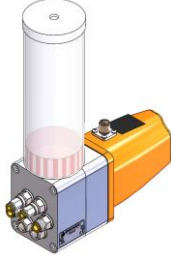
#### 3.8.2 Piston pump GMK-B

Article description	Version	Symbol	Picture	Documentation
<p>Driven by electric motor 24 VDC; max. 0.5 A; Outlets: 1 ... 6; Container systems: 125 / 250 / 380 ml containers, Grease cartridges 400 g DIN 1284, Filling connection: Waltherkupplung MD-006-2-WR013; Plug M12x1; Outlet: <math>\varnothing 4 / \varnothing 6 / G1/8</math>; Delivery volume per outlet/stroke: 40 mm<sup>3</sup>; Function control; Level control: Min/adv; Cartridge control as standard; Overpressure shut-off; Dual-circuit lubrication possible (S2C); Temperature monitoring</p>	<p>GMK-B/00/X/125(S)/D/X/X GMK-B/00/X/250(S)/D/X/X GMK-B/00/X/380(S)/D/X/X GMK-B/00/X/40/D/X/X</p> <p>+ 112.663-72 (customised assembly)</p> <p>X <math>\triangleq</math> (Freely selectable according to data sheet)</p>			<p><a href="#">Data sheet</a> <a href="#">3D-model</a></p>

### 3.8.3 Containers for GMK-B

Article description	Version	Symbol	Picture	Documentation
cartridge container 380ml 250ml 125ml	112.629-65			<a href="#">Data sheet</a>
	112.629-67			
	112.629-68			
Grease cartridge 400g DIN 1284	112.622-65			<a href="#">Data sheet</a>

### 3.9 Volume flow regulator and limiter \*

*\*to be used exclusively in the "Foundry" area*

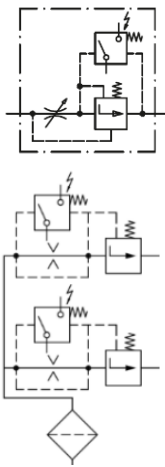
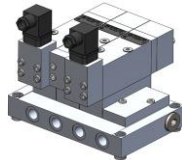
Article description	Version	Symbol	Picture	Documentation
Volume flow regulator: Volume flow 0.1 to 5 l/min continuously adjustable;  Volume flow limiter: Volume flow 0.5 to 16 l/min adjustable via orifices	Volume flow meter with connection board VUA-B/00/X/.../X/V			VUA-B: <a href="#">Data sheet</a>
	Volume flow limiter with connection board VUK-A/00/X/.../X			VUK-A: <a href="#">Data sheet</a>
	Volume flow limiter with connection board VUL-A/00/X/.../X			VUL-A: <a href="#">Data sheet</a>
	X ≙ (Freely selectable according to data sheet)			

### 3.10 Volume flow monitoring devices

#### 3.10.1 Flow checking device KPD\*

*\*to be used exclusively in the "Foundry" area*

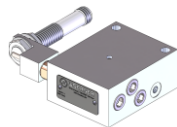
Article description	Version	Symbol	Picture	Documentation
Flow control according to the progressive system; Medium: oil and grease; max. 180 or 70 cm <sup>3</sup> /min; One switching pulse per 0.8 or 1.2 cm <sup>3</sup>	KPD-X/00/X/X			<a href="#">Data sheet</a>
	X ≙ (Freely selectable according to data sheet)			

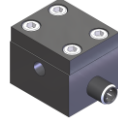

### 3.10.2 Oval gear flowmeter KUO-A\*

\*to be used exclusively in the "Foundry" area



Article description	Version	Symbol	Picture	Documentation
Flow control via a pair of gears; Medium: oil or grease; 0 ... 2.5 l/min; Operating pressure up to 700 bar				<a href="#">Data sheet</a>

## 4. Accessories

### 4.1 Hoses

Article description	Version	Symbol	Picture	Documentation
Hydraulic hoses for lubrication lines for self-assembly Nominal diameter 4 ... 10 mm Straight or 90° bent pipe sockets Connecting pieces made of steel for nominal width 4 and 6 mm also in 1.4571	ZSH-D/00/X/X  X $\triangleq$ (Freely selectable according to data sheet)			<a href="#">Data sheet</a>

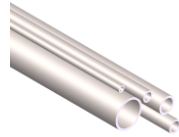

### 4.2 Pipelines

Article description	Version	Symbol	Picture	Documentation
Hydraulic steel pipes; Outer diameter 4 ... 28 mm; galvanized + stainless steel version				<a href="#">Data sheet</a>
Hydraulic polyamide pipes; Outlet diameter 2.5...8 mm				<a href="#">Data sheet</a>



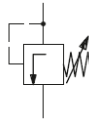

## 4.3 Pressure relief valves

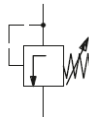

### 4.3.1 Pressure relief valve for line installations

Article description	Version	Symbol	Picture	Documentation
Pressure relief valve HDB-A for line protection; Medium: oil, grease up to NLGI class 3; Opening pressure adjustable up to max. 150 bar; Connection: G1/4 or pipe connection $\varnothing 6... \varnothing 12$ ; optionally with or without pressure gauge; Material: brass; Traceable	HDB-A/00/X/X/X/EX  X $\triangleq$ (Freely selectable according to data sheet)			<a href="#">Data sheet</a>

### 4.3.2 Pressure relief valve for gear pumps

Article description	Version	Symbol	Picture	Documentation
Pressure relief valve for installation in the GFZ and GFM gear pumps; Medium: Oil 18...1690 mm/s; Opening pressure 2.5 to 60 bar; Material: steel; Connection: HDV-A screw-in connector	HDV-X/00/X/X  X $\triangleq$ (Freely selectable according to data sheet)			<a href="#">Data sheet</a>

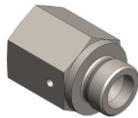
### 4.3.3 Pressure relief valves for pump elements

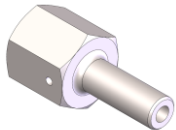
Article description	Version	Symbol	Picture	Documentation
Pressure relief valve for pump elements of the GMA piston pump; Direct installation in the pump element; Opening pressure 50...400 bar	(Order numbers see data sheet GMA-B/-C)			<a href="#">Data sheet</a>
Pressure relief valve for pump elements of the GMO-A piston pump; Adjustable and fixed setting available; Opening pressure 50...300bar	(Order numbers see data sheet GMO-A)			<a href="#">Data sheet</a>

## 4.4 Check valves

*\*Note: Only soft-sealing screw connections of type EO2 should be used up to the main distributor. From the dosing element onwards, other pipe fittings can also be used.*

### 4.4.1 Check valve for VPA-B

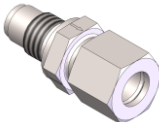
Article description	Version	Symbol	Picture	Documentation
Check valve in distributor outlets of the VPA-B; Connection G1/8 and G1/4; Pipe connection Ø6...10mm; Opening pressure: G1/8 - 6.5bar, G1/4 - 3bar Material: galvanized steel	(Order numbers see data sheet)			<a href="#">Data sheet</a>

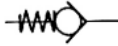
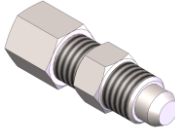
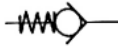
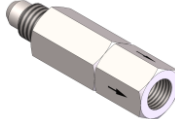

### 4.4.2 Check valve for VPB-B

Check valve ALL in distributor outlets of the VPB-B; Connection M10x1; Pipe connection Ø4 and Ø6; Opening pressure: 3bar Material: galvanized steel	(Order numbers see data sheet)			<a href="#">Data sheet</a>
Check valve without pipe fitting in VPB-B manifold outlets; Connection M10x1; Outlet M10x1; Opening pressure: 1 bar Material: galvanized steel	(Order numbers see data sheet)			<a href="#">Data sheet</a>

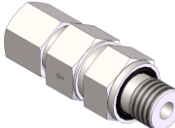
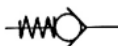
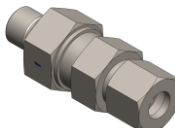

### 4.4.3 Check valves in general

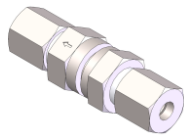
Check valve for distributor outlets LR-KVV; Connections: G1/8, G1/4, G1/2, G1, G1 ½; Pipe connections Ø6...30mm Material: galvanized steel or stainless steel	(Order numbers see data sheet)			<a href="#">Data sheet</a>
Check valve for manifold inlets LR-KVZ; Connections: G1/8, G1/4, G3/8, G1/2; Pipe connections Ø6...18mm; Material: galvanized steel or stainless steel	(Order numbers see data sheet)			<a href="#">Data sheet</a>



#### 4.4.4 Check valve for line installation

<p>Check valve for line installation L-KV; Pipe connections on both sides <math>\varnothing 6...42\text{mm}</math>; Material: galvanized steel or stainless steel</p>	<p>(Order numbers see data sheet)</p>			<p> <a href="#">Data sheet</a></p>
---	---------------------------------------	---	---	---

#### 4.5 Push-in fittings

Article description	Version	Symbol	Picture	Documentation
<p>Push-in fittings for quick pipe assembly without tools; Can be used in lubrication systems and compressed air systems; Permissible pressure: 150bar; -20...70°C; Material: Nickel-plated brass body, brass collet; Various threaded connections are available</p>	<p>Straight screw-in fitting with or without non-return valve</p> <p>Straight Y-hose connector</p> <p>Swivelling elbow fitting</p> <p>(Order numbers see data sheet)</p>			<p> <a href="#">Data sheet</a></p>

#### 4.6 Pressure gauge



Article description	Version	Symbol	Picture	Documentation
<p>Pressure gauge with bourdon tube and glycerine filling; Nominal size NG63; Pressure range: 0...600bar; Stainless steel housing; Available with various connection threads; Red-green arcs, ranges can be customised using stickers</p>	<p>0 – 40 bar: 943.800-36</p> <p>0 – 60 bar: 943.800-95</p> <p>0 – 250 bar: 943.800-41</p> <p>Accessories for pressure gauges: + 943.805-71 Sticker set for red and green arcs, NG63</p>			<p> <a href="#">Data sheet</a></p>

#### 4.7 Filters



##### 4.7.1 Oil filter

See release list:  
Filtration Group

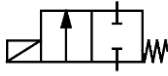

#### 4.7.2 Lubricant filter

Article description	Version	Symbol	Picture	Documentation
Single filter for in-line installation; Connection: G1/4; Medium: Grease up to NLGI class 3; Pressure up to 250 bar; Filter mesh size: 300 µm	112.042-65			<a href="#">Data sheet</a>

#### 4.8 Directional valves

Article description	Version	Symbol	Picture	Documentation
2/2 and 3/2-way solenoid valve for controlling lubrication circuits; Medium: Oil min. 4mm <sup>2</sup> /s, grease up to NLGI class 000-2; Operating pressure max. 400 bar; Volume flow max. 20 l/min; Voltage: 24 VDC; Connection block with connection threads G3/8	2/2-way valve: 945.205-54  3/2-way valve: 945.205-53  + 913.405-47 (Adapter M12x1)			<a href="#">Data sheet</a>

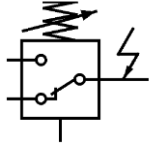
#### 4.9 Pressure switch

Article description	Version	Symbol	Picture	Documentation
Electronic pressure switch for installation in hydraulic lines; With LED display; Medium: Liquid media; Setting range: 1...100bar; Voltage: 18...30V DC; Pressure connection: G1/4i; Electrical connection: M12x1; 2 digital outputs, 1x switching signal and 1x IO-Link; Model: PN7092	940.405-98			<a href="#">Data sheet</a>

#### 4.10 Mounting plates / oil pans

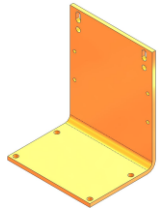
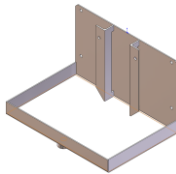
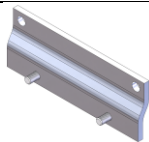
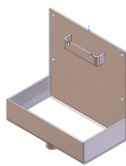
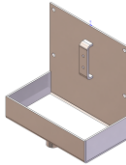
Article description	Version	Symbol	Picture	Documentation
Mounting bracket for fixing the GMO-A and GMA-B/-C to the floor; steel	112.757-64			<a href="#">Dimension drawing</a>
Mounting plate with oil pan for GMO-A and GMA-B/-C; Stainless steel 1.4301	112.758-67			<a href="#">Dimension drawing</a>
Mounting plate for attaching the GMK-B piston pump; Stainless steel	112.620-65			<a href="#">Dimension drawing</a>
Mounting plate with oil pan for mounting the GMK-B piston pump; Stainless steel 1.4301	112.620-66			<a href="#">Dimension drawing</a>
Mounting plate with oil pan for mounting the GMV piston pump; Stainless steel 1.4301	105.341-66			<a href="#">Dimension drawing</a>

#### 4.11 Check valve cartridges for GMK-B

Article description	Version	Symbol	Picture	Documentation
Check valve cartridges are the outlet fittings of the GMK-B; Material: brass; Threaded connection G1/8, Push-in connections for $\varnothing 4$ and $\varnothing 6$ mm polyamide pipes	<p>Check valve cartridge with G1/8 threaded connection for pipe fittings + 112.626-45</p> <p>Check valve cartridge with push-in connection for PA pipe <math>\varnothing 4</math> +112.627-47</p> <p>Check valve cartridge with push-in connection for PA pipe <math>\varnothing 6</math> + 112.625-47</p>			<a href="#">Data sheet</a> <a href="#">3D-model</a>



#### 4.12 Chain lubrication pinion

Article description	Version	Symbol	Picture	Documentation
<p>Chain lubrication pinion for lubricating chain plates; Material: open-cell PU foam, sprocket made of wear-resistant plastic, other components made of steel; Types: straight axle, spring plate on one side, spring plate on both sides</p>	(Order numbers see data sheet)			<a href="#">Data sheet</a>

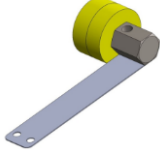
#### 4.13 Lubrication roll

Article description	Version	Symbol	Picture	Documentation
<p>Lubrication roll for lubricating surfaces and chains; Material: open-cell PU foam, other components made of steel; Types: straight axle, spring plate on one side, spring plate on both sides</p>	(Order numbers see data sheet)			<a href="#">Data sheet</a>

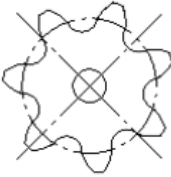
#### 4.14 Lubrication gear

Article description	Version	Symbol	Picture	Documentation
<p>Lubricating gear for the lubrication of drive pinions or gear racks; Medium: Oil, fluid grease or grease; Material: Type E made of EPP foam, type P made of PU foam, type H made of HMPE plastic, type A made of aluminium; Individual number of teeth</p>	<p>2...30/X/.../X</p> <p>X ≙ (Freely selectable according to data sheet)</p>			<a href="#">Data sheet</a>